





Model Code: Q200U

Included Accessories

 Undermount Clip	 6020	 AQCB
 ADT1		

Optional Accessories

 DBR10S	 CBB475U	 DR006

Dimensions

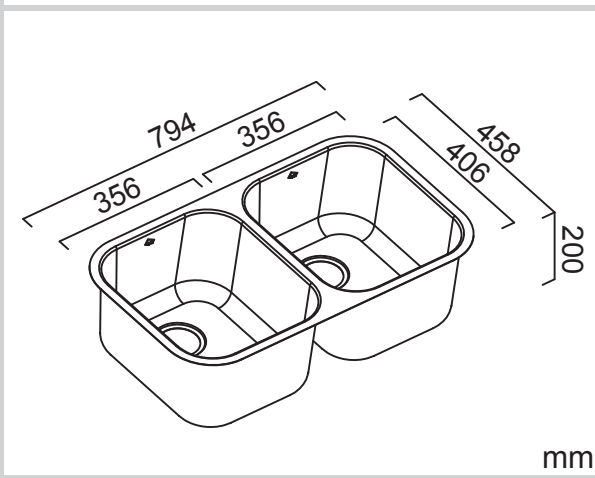

Specifications

Description	Double bowls, undermount sink
Overall Sink Size	794mm x 458mm x 200mm deep
Bowl Dimensions	356mm x 406mm x 200mm deep 356mm x 406mm x 200mm deep
Drainer Length	N/A
Technic	Press
Material	Stainless steel SUS304

Installation

Fixings	Undermount clips supplied
Template	Supplied
Min Cabinet Size	834mm
Waste Holes	2 x 90mm round Compatible with waste disposal

SURFACE FINISH



WASTE KIT

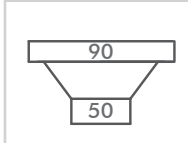

MATERIAL

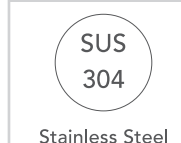

INSTALLATION OPTIONS

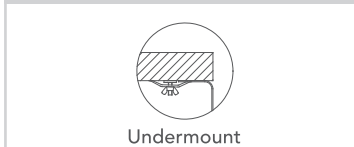

PROFILE

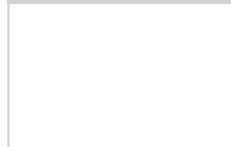

Plumbing

Waste Fittings	2 x (90mm x 2") basket wastes included
Overflow	Available, conditions apply

Packaging

Carton Type	EPS protection & individual carton
Gross Weight	11.24Kg
Carton Size	900mm x 530mm x 275mm
Pack QTY	1

Abey are Australia's leaders in sinkware, designing and manufacturing to the world's highest quality specifications as well as sourcing and bringing you Europe's very best, leading edge designs – practical, affordable, inspirational, stylish, timeless or cutting edge. When you buy an Abey stainless steel sink you receive the highest quality and 25 year warranty. Abey and the manufacturer are continually seeking ways to improve the design specifications, aesthetic and production techniques of the products. As a result, alterations to the specifications and dimensions of the products and designs occur continually.